



SmartVent
lite+

HOME VENTILATION SYSTEMS



Firmware Version 3.4

User Manual

Your guide to a healthier home

Warning

- This appliance is not intended for use by persons (including children) with reduced physical, sensory or mental capabilities, or lack of experience and knowledge, unless they have been given supervision or instruction concerning use of the appliance by a person responsible for their safety.
- Children should be supervised to ensure that they do not play with the appliance.
- Isolate the mains supply before attempting to replace the system's air filter.

SmartVent Lite+ System

Firmware Version 3.4

Contents

Home Screen Icons	4
Button Functions.....	4
Screen Highlights.....	5
Modes	
Auto Operation and Temperature Setting	5
Manual Operation and System Fan Speed Setting	5
Boost	6
Recycle	6
Fan OFF Setting.....	6
Key Lock Setting.....	6
Relative Humidity	7
Dew Point.....	7
System Time-Date Settings.....	8
System Operating Settings	
Scheduler Settings.....	9
Period OFF/ON Settings.....	10
Period Schedule Log	11
Advanced Settings	
Advanced Settings Selection.....	11
Advanced Settings Menu.....	12
Troubleshooting	13
Technical Specifications	14



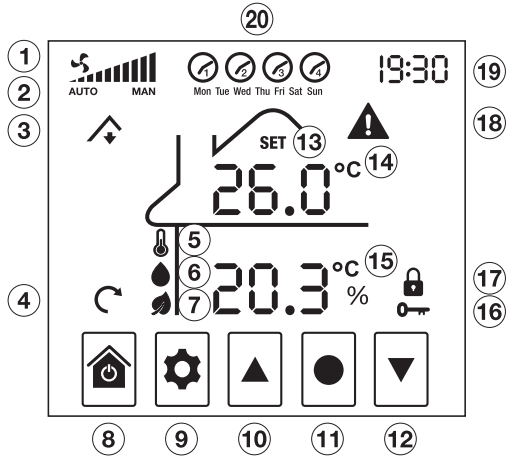

Home Screen Icons

- ① System Fan Speed
- ② Ventilation Mode ¹⁾
- ③ Air Source Indicator
- ④ Recycle ON
- ⑤ Temperature Sensing ON
- ⑥ Dew Control Mode ON
- ⑦ Dew Point Temperature
- ⑧ Home and Power
- ⑨ Settings
- ⑩ Up
- ⑪ Select
- ⑫ Down
- ⑬ Set ²⁾
- ⑭ Fresh Air Temperature ²⁾ or
Fresh Air Relative Humidity ³⁾
- ⑮ Current Room Temperature or
Current Room Relative Humidity ⁴⁾
- ⑯ Key Lock ON
- ⑰ Rental Mode ON ⁵⁾
- ⑱ Alert ⁶⁾
- ⑲ Time ⁷⁾
- ⑳ Scheduler Period and Day



- 1) Ventilation mode selections are AUTO or MAN (manual)
- 2) The SET icon will appear when the temperature is being changed and the progressive temperature changes being made will be displayed instead of the Fresh Air temperature
- 3) Relative Humidity value is showing if the °C symbol is not displayed
- 4) Relative Humidity value is showing if the percentage % symbol is displayed instead of the °C symbol.
- 5) When RENTAL mode is ON, fan OFF setting and Scheduler is disabled
- 6) When an electronic fault in the system occurs, the alert icon will appear and the applicable error code(s) will be displayed instead of the time
- 7) Time is displayed in a 24 hour clock format

Button Functions

-  Power OFF/ON or discard selections and return to Home Screen
-  From Home Screen enter setting screen or return to previous setting option
-   Scroll through setting options and change setting values
-  Save setting selection and go to next setting option

Screen Highlights

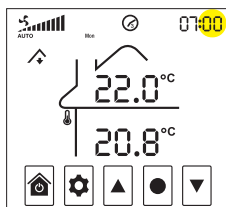

Yellow highlight
indicates icon
is flashing

Green highlight
indicates button(s)
to push







Modes

Auto Operation and Temperature (TEMP) Setting

Your SmartVent Lite+ system can choose at what speed to draw air depending on the indoor and outdoor air temperatures, when in AUTO. If the system is in either BOOST or RECYCLE modes, the fan will, instead, operate at the speeds set for those particular modes.

You select the SET temperature you want it to be in the home (ie. 22°C (default)) and the system will work on the best air source to achieve your SET temperature ¹⁾.

For example, if you set your system to 20°C while the current house temperature is 18.3°C, the control system measures the incoming air temperature and alters the fan speed to suit. If the incoming air temperature is 20°C or higher, the fan will operate at a high speed to use the free heat to try and increase the overall house temperature. If lower than 20°C, the fan speed would decrease to reduce the cooling effect ²⁾.



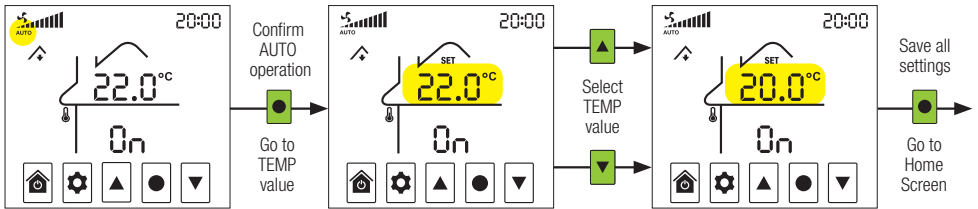



- On the Home Screen, press SETTINGS  and then UP , or DOWN , to toggle to ON
- Press SELECT  to enter VENTILATION mode
- Press UP , or DOWN , to toggle to AUTO operation and follow the guide below to adjust the temperature setting.
- Alternately, if already in ON and on the Home Screen, press SELECT  to toggle directly to AUTO operation and follow the same guide below to adjust the temperature setting.



- 1) Your system is not a heating or cooling device. This parameter is designed to reduce nuisance over-heating or over-cooling of your home.
- 2) Additional features are available when low temperatures are present. See RECYCLE mode.

Manual (MAN) Operation and System Fan Speed and Air Source Settings

Your SmartVent Lite+ system allows manual control of the fan speed if required. Fan speed will remain constant at the speed set. If the system is in either BOOST or RECYCLE modes, the fan will, instead, operate at the speeds set for those particular modes.

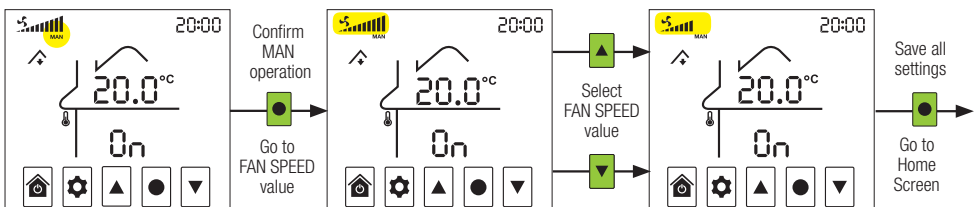

- On the Home Screen, press SETTINGS  and then UP , or DOWN , to toggle to VENTILATION mode
- Press SELECT  to enter VENTILATION mode and then UP , or DOWN , to toggle to MAN operation and follow the guide below to complete the setting of the system fan speed and the selection of the air source.
- Alternately, if already in ON and on the Home Screen, press SELECT  to toggle to MAN operation and follow the same guide below to change the system fan speed.



Modes

Boost

BOOST enables you to immediately override fan speed settings and boost fan speed to maximum.

- On the Home Screen, press SELECT  for 3 seconds and system's fan will boost to maximum speed.
- In BOOST mode, the time segments will become a count down to the end of the BOOST mode.
- A quick tap of SELECT  on the Home Screen will exit BOOST mode.

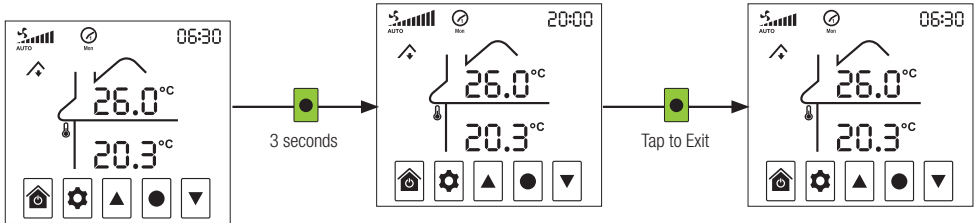

Recycle

RECYCLE is designed for environments where extremes of temperature are common. When your system is in VENTILATION mode and the roof cavity temperature exceeds the maximum roof cavity temperature (default = 30°C) setting, or goes below the minimum roof cavity temperature (default = 5°C) setting, your SmartVent system will limit the amount of air entering your home.

RECYCLE  icon will be displayed when your system is in RECYCLE mode. In Advanced Setting Menu, RECYCLE mode can be disabled (setting 007), Recycle Speed can be adjusted (setting 008) and temperature settings can be adjusted (settings 009 and 010). The fan will operate on Recycle Speed (default = OFF) during RECYCLE mode.

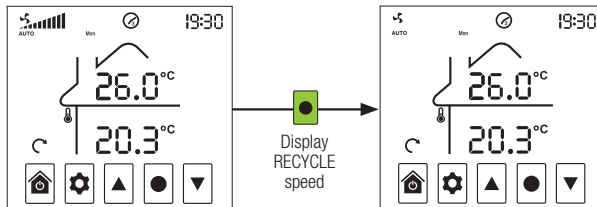







Fan OFF Setting

- On the Home Screen, press SETTINGS  and then UP , or DOWN , to toggle to OFF
- Press SELECT  to save the fan OFF setting.

Key Lock Setting

When Key Lock is ON, system settings cannot be changed

- Press UP  and DOWN  together for 3 seconds, until the KEY LOCK  icon is displayed, to confirm that the system is locked.
- Press UP  and DOWN  together for 3 seconds, until the KEY LOCK  icon is not displayed, to confirm that the system is unlocked.

Relative Humidity

The current Relative Humidity percentages in the roof cavity and the room can be viewed at any time.

- On the Home Screen, press UP ▲, or DOWN ▼, for 3 seconds to display the Relative Humidity percentages in both the roof cavity and the room
- The display will automatically return to the Home Screen after 3 seconds

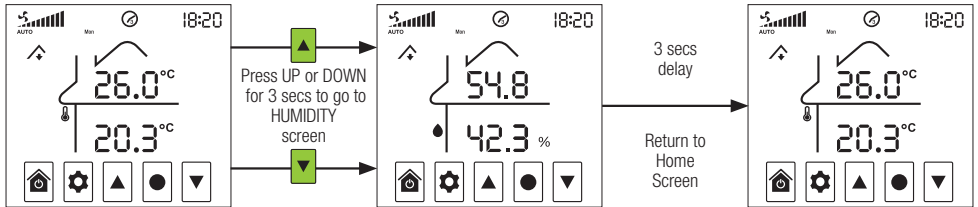

Dew Point

The current Dew Point temperatures in the roof cavity and the room can be viewed at any time.

- On the Home Screen, press UP ▲, or DOWN ▼, for 3 seconds to display the Relative Humidity percentages in both the roof cavity and the room
- Within 3 seconds after the Relative Humidity percentages are displayed, press UP ▲, or DOWN ▼, again for 3 seconds to display the Dew Point temperatures in both the roof cavity and the room
- The display will automatically return to the Home Screen after 3 seconds

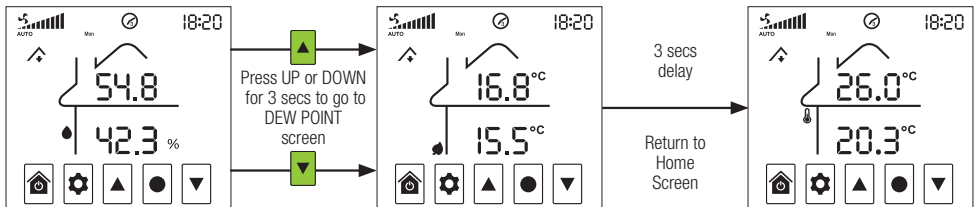



System Time-Date Settings

System Time-Date Settings must be entered before system functions, such as scheduled start times, can be set.

- On the Home Screen, press **SETTINGS**  for 3 seconds to enter Time-Date Settings and follow the guide below to complete

NOTE: Settings shown are examples only

- Press **HOME**  at any stage to exit and enter Scheduler Settings
- Press **SETTINGS**  at any stage to return to the previous screen

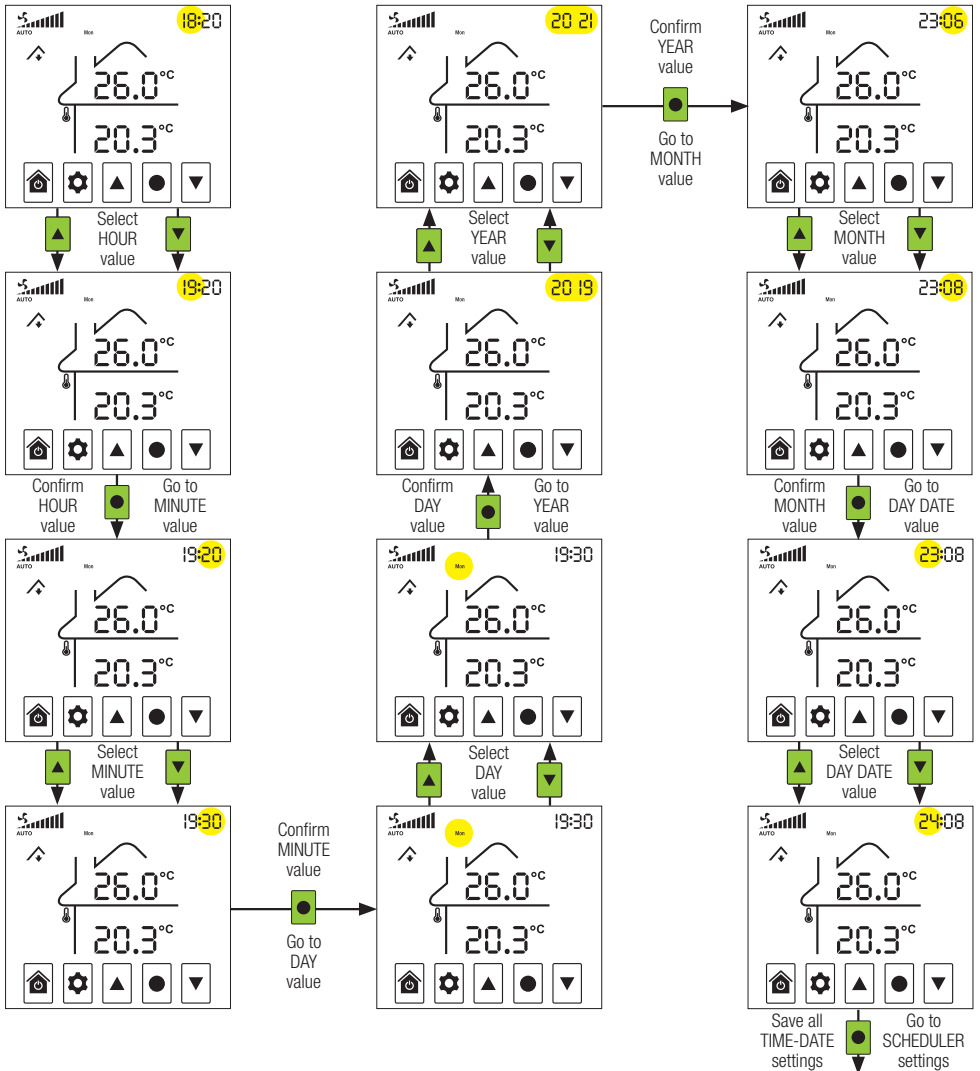

System Operating Settings



Scheduler Settings





Setting the Scheduler is only necessary if you wish to control whether the system is OFF or ON during each of the four periods available in a 24 hours period.

A period start time is also the previous period end time.

- On the Home Screen, press SETTINGS  for 3 seconds then press HOME  to enter Scheduler Settings and follow the guide below to complete

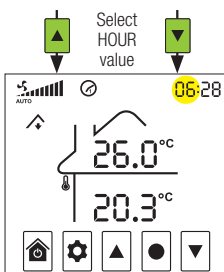
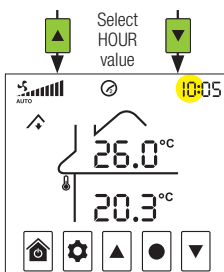
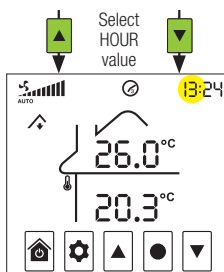
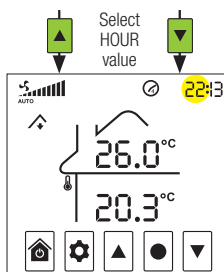
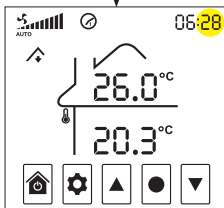
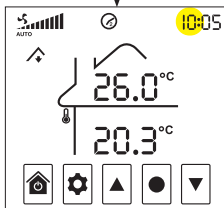
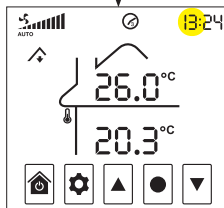
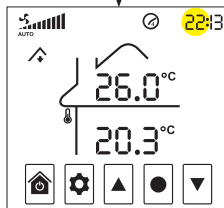
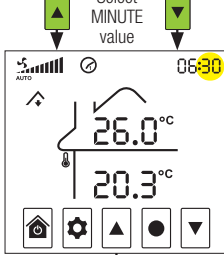
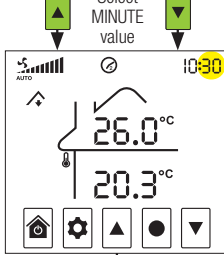
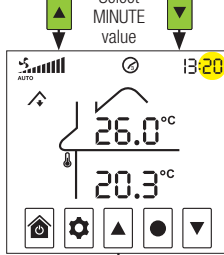
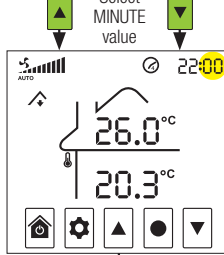
NOTE: Settings shown are examples only

- Press HOME  at any stage to exit Scheduler Settings and return to the Home Screen
- Press SETTINGS  at any stage to return to the previous screen

Period 1	Period 2	Period 3	Period 4
 <p>Select HOUR value</p>	 <p>Select HOUR value</p>	 <p>Select HOUR value</p>	 <p>Select HOUR value</p>
 <p>Confirm HOUR value</p>	 <p>Confirm HOUR value</p>	 <p>Confirm HOUR value</p>	 <p>Confirm HOUR value</p>
 <p>Select MINUTE value</p>	 <p>Select MINUTE value</p>	 <p>Select MINUTE value</p>	 <p>Select MINUTE value</p>
 <p>Confirm all PERIOD 1 settings</p>	 <p>Confirm all PERIOD 2 settings</p>	 <p>Confirm all PERIOD 3 settings</p>	 <p>Save all PERIOD 1-4 settings</p>

System Operating Settings



Period OFF/ON Schedule

Set VENTILATION mode to AUTO operation (see page 5).

Fan speed will adjust automatically based on the Dew Point and then indoor/outdoor air temperatures. If system is in either BOOST or RECYCLE modes, the fan will operate at speeds set for those modes.

- On the Home Screen, press SETTINGS  to enter Period OFF/ON Schedule and follow the guide below to complete the fan OFF/ON settings for each of the four periods available in a 24 hour period.

NOTE: Settings shown are examples only and OFF periods should only be scheduled if absolutely necessary.

- Press HOME  at any stage to exit Period OFF/ON Schedule and return to the Home Screen
- Press SETTINGS  at any stage to return to the previous screen

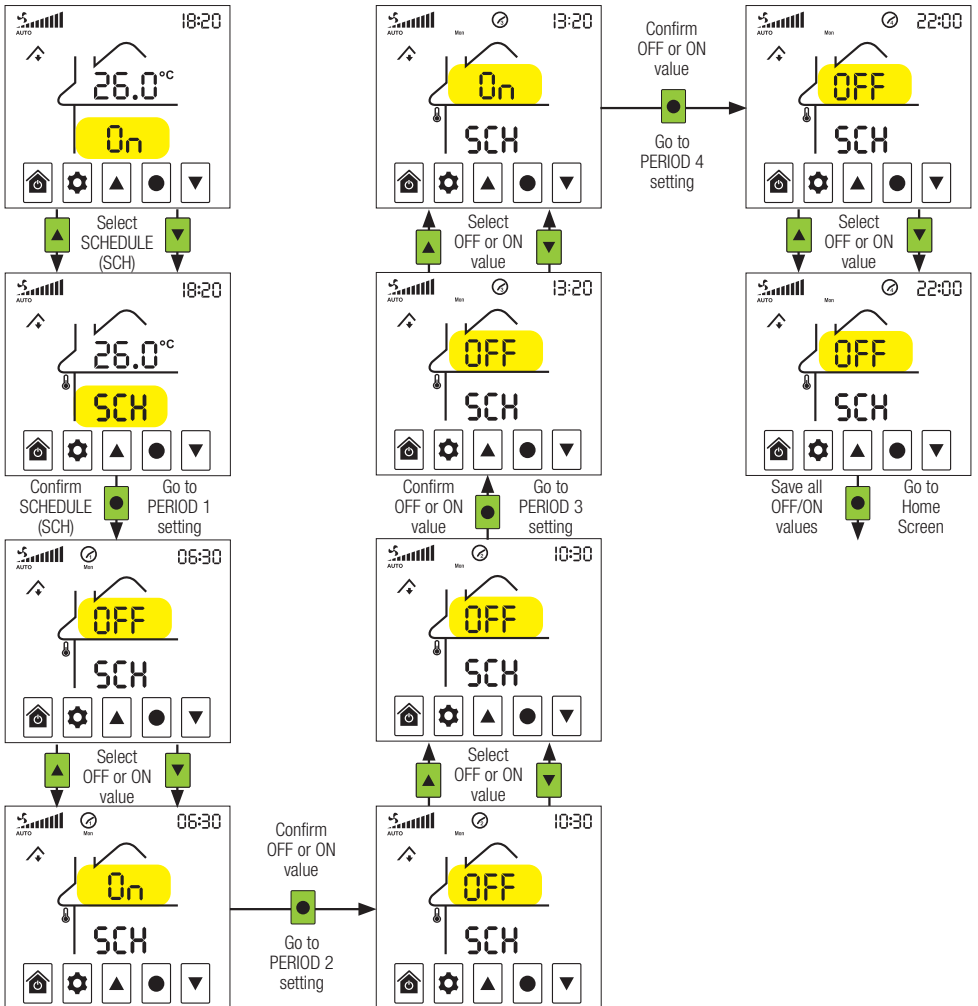

System Operating Settings

Period Schedule Log

Record your scheduled start times and OFF/ON status in the Period Schedule Log below.

Date	Period 1			Period 2			Period 3			Period 4		
	Start	OFF	ON	Start	OFF	ON	Start	OFF	ON	Start	OFF	ON

Advanced Settings

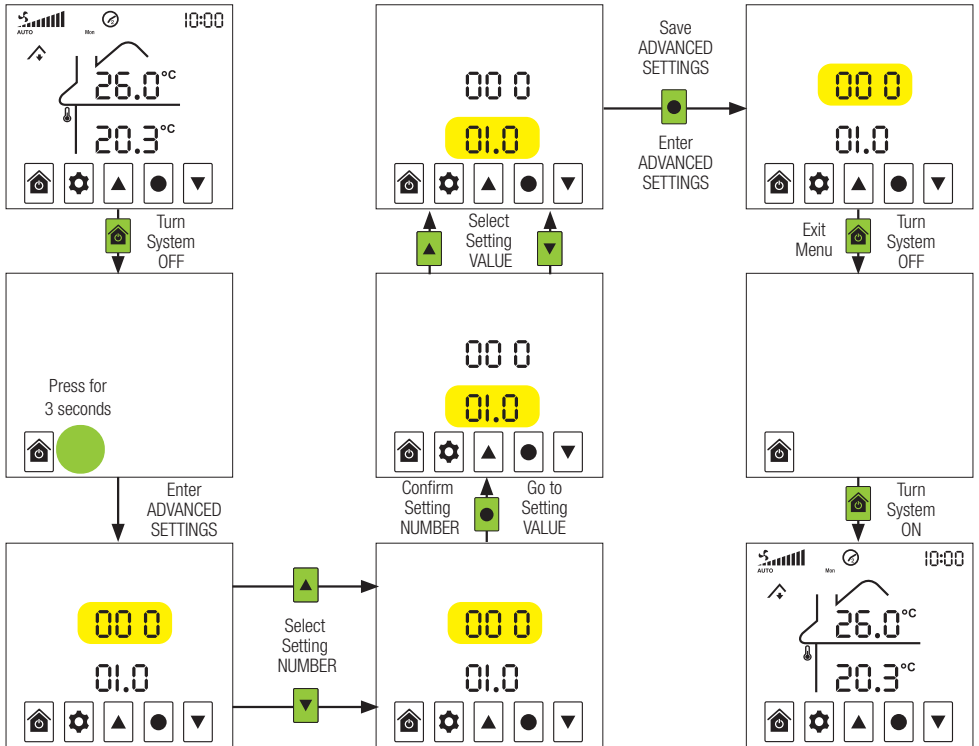

Advanced Setting Selection

Advance Settings enable you to change your SmartVent Lite+ system settings at any time to ensure you gain maximum benefit of comfortable living conditions in a healthy home. Access to Advanced Settings is disabled when RENTAL mode is ON.



Advanced Setting Menu

SETTING	DESCRIPTION	RANGE	DEFAULT	NOTE
000	Hardware Version	N/A	3.1	
001	Firmware Version	N/A	3.4	
002	Temperature - Room	-10°C - 10°C	-2.5°C	1
003	Temperature - Roof Cavity	-10°C - 10°C	0°C	1
004	Screen Brightness - Maximum	0 - 100%	80%	
005	Screen Brightness - Minimum	0 - 100%	20%	
006	Boost Time	0 min - 60 min	20 min	
007	Recycle Enable	0 - 1	1	1 = enabled
008	Recycle Speed	0 - 100%	0%	
009	Recycle Temperature - Maximum	Recycle Min. Temp - 50°C	30°C	2
010	Recycle Temperature - Minimum	0°C - Recycle Max. Temp	5°C	2
011	Temperature Set - Threshold	0°C - 5°C	1.5°C	
012	Temperature Set - Differential	0°C - 20°C	5°C	
013	Reserved	N/A	N/A	
014	Reserved	N/A	N/A	
015	Dew Point - Start	-5°C - 5°C	0°C	
016	Dew Point - Control Level	0 - 5	1	
017	Filter Used Percentage	0 - 100%	0%	
018	Filter Reset	0 - 100	0	3

1. If your roof cavity or room temperature readings are inaccurate, use these settings to calibrate them.
2. If RECYCLE  is enabled and the roof cavity sensor reading goes above the maximum recycle temperature setting or goes below the minimum recycle temperature setting, then recycle mode will activate.
3. To reset the filter change 018 setting value to 10 and press SELECT .

Troubleshooting

An ALERT  icon and an error code will appear on the Home Screen when there is an electronic fault in the system.

If there are multiple faults the error codes will cycle to the next code periodically.

Contact SmartVent for assistance if error codes not listed above appear or the actions above do not clear the errors.

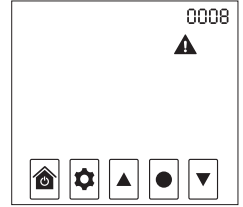

CODE	DESCRIPTION	ACTION
0008	Onboard sensor COM error	Contact Tech Support
0010	Onboard temperature sensor data is invalid	
0020	Onboard humidity sensor data is invalid	
0040	Fresh air relative humidity sensor COM error	Installer to check wiring connection or for damage to sensor cable
FILT	Filter change required	Replace filter and reset filter by changing Advanced Setting 018 to 10 and pressing SELECT to confirm

Technical Specifications

TOUCH SCREEN CONTROLLER V3.4	
Temperature Range	5-35°C adjustable
Display Resolution	0.1°C
Operating Voltage/Frequency	220-240V AC, 50Hz
Switching Voltage	240V AC Max
Switching Current	3A max resistive load
Sensing Element	Thermistor
Operating Temperature	0 to 40°C
Operating Humidity	5-90% non condensing
Live Output Isolation	Relay
Output Control	Relay / 0-10V DC
Display	3.5" digital LCD touch screen
Approval	All relevant AS/NZS standards
EMC Approval	All relevant AS/NZS standards  E6337

Specifications are subject to change without notice

Contact: 0800 140 150
enquiry@smartvent.co.nz



Distributed by Simx Limited
PO Box 14347, Panmure, Auckland, New Zealand.
Technical Support (09) 259 1662 | e: sales@simx.co.nz | w: www.simx.co.nz

PUB1637 2011